

<b>PRODUCT NO.</b> DISC01SJGET	<b>RoHS compliant</b>
-----------------------------------	-----------------------

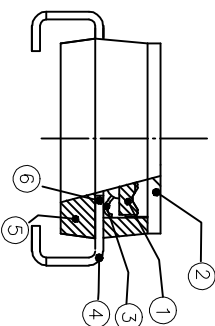

(Construction)

**RECOMMENDED P.C.B. LAYOUT (TOP VIEW)**

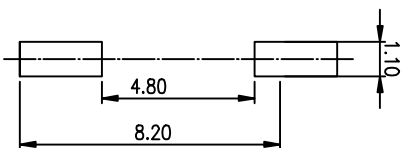
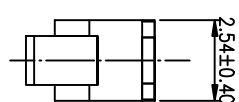
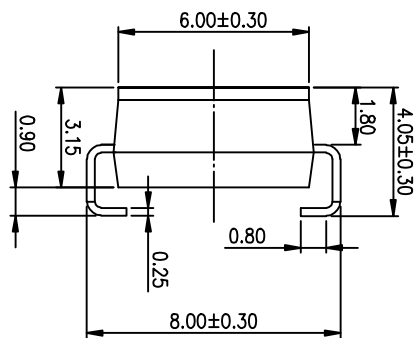
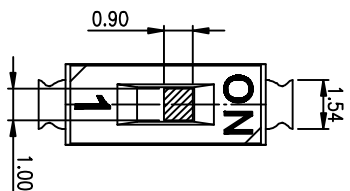
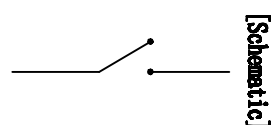

[Schematic]

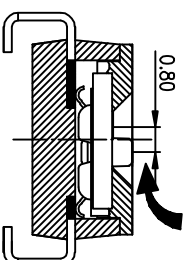

[推板行程]

- NOTES :
- 1>.Specification:
- 1>.Operating force:1000gf Max
  - 2>.Operating Temperature: -40° to+85°
  - 3>.Storage Temperature: -40° to+85°
  - 4>.Mechanical Life: 3000cycles minimum
  - 5>.Electrical Life: 2000cycles 25mA 24VDC
2. PLATING:
- GOLD FLASH 1u"(min.) SOLDER TAIL,  
3u" GOLD PLATING ON THE CONTACT AREA,  
WITH 50u" NICKEL UNDERPLATINGOVERALL.

3. PART NUMBER DESCRIPTION

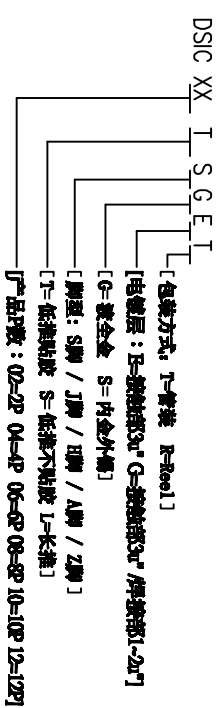

Number	Part Name	Material	Finished
①	Actuator	UL94 V0	White
②	Cover	UL94 V0	Black
③	Movable	Copper Alloy	3u"Gold
④	Terminal	Brass	1u"Gold
⑤	Base	UL94 V0	Black
⑥	Terminal Contact	Brass	3u"Gold

TOLERANCE UNLESS OTHERWISE SPECIFIED		INSPECTION COPY	
LINER	ANGLES	PROJECTION	COPY
0 ± 0.25	0. ± 2°	⊕	
.00 ± 0.15	.0 ± 1°	⊖	
.000± 0.10	.00± 0.5°		
DESIGN	kathy	2012/04/12	
DRAWING			
CHECK			
APPRO.			

**德普特精密電子股份有限公司**  
Dongguan Kingtek Industrial Co., Ltd.

FILE NO. DISC01SJGET-A  
SIZE UNIT SCALE SHEET REV.  
A4 mm 2 : 1 1OF 1 A