

PRODUCT NO.	DISCO1LJGET
RoHS compliant	

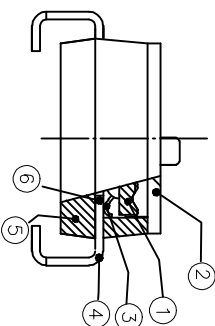

RECOMMENDED P.C.B. LAYOUT (TOP VIEW)

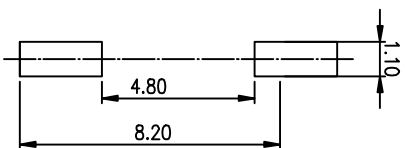
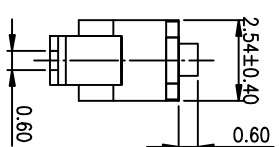
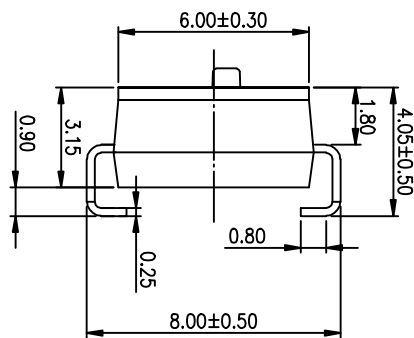
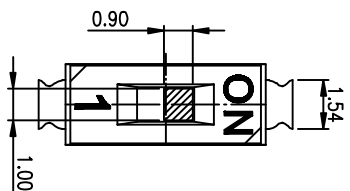
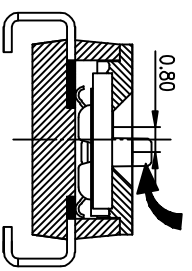
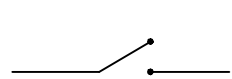

- NOTES :
- 1>.Specification:
- 1>.Operating force:1000gf Max
 - 2>.Operating Temperature: -40° to+85°
 - 3>.Storage Temperature: -40° to+85°
 - 4>.Mechanical Life: 3000cycles minimum
 - 5>.Electrical Life: 2000cycles 25mA 24VDC
2. PLATING:
- GOLD FLASH 1u"(min.) SOLDER TAIL,
3u" GOLD PLATING ON THE CONTACT AREA,
WITH 50u" NICKEL UNDERPLATINGOVERALL.

3. PART NUMBER DESCRIPTION

- DISC XX I T S G E T
- [包裝方式: T=管裝 R=盒裝]
 - [電鍍層: B=鍍銀3u" G=鍍鎳3u" / 鍍鎳3u"-2u"]
 - [G=鍍合金 S=內金外鍍]
 - [潤滑: S潤 / J潤 / 環 / A潤 / Z潤]
 - [T=低摩擦度 S=低摩擦度 L=長推]
 - [T產品數: 02=2P 04=4P 06=6P 08=8P 10=10P 12=12P]

Number	Part Name	Material	Finished
①	Actuator	UL94 V0	White
②	Cover	UL94 V0	Black
③	Movable	Copper Alloy	3u"Gold
④	Terminal	Brass	1u"Gold
⑤	Base	UL94 V0	Black
⑥	Terminal Contact	Brass	3u"Gold

TOLERANCE UNLESS OTHERWISE SPECIFIED		INSPECTION COPY	
LINER	ANGLES	PROJECTION	
0 ± 0.25	0. ± 2°	①	
.00 ± 0.15	.0 ± 1°	②	
.000± 0.10	.00± 0.5°	③	
DESIGN	kathy	2012/04/12	
DRAWING			
CHECK			
APPRO.			

東莞精特電子股份有限公司 Dongguan Kingtek Industrial Co., Ltd.			
TITLE			
BY DISC SERIES PITCH 2.54mm			
PRODUCT FAMILY DISC SERIES			
FILE NO.	DISCO1LJGET-A	PRAT NO.	DISCO1LJGET
SIZE	UNIT SCALE	SHEET	REV.
A4	mm	2 : 1	1 OF 1 A